

**ebm-papst St. Georgen GmbH & Co. KG**

Hermann-Papst-Str. 1

D-78112 St. Georgen

Phone +49 (0) 7724 81-0

Fax +49 (0) 7724 81-1309

info2@de.ebmpapst.com

www.ebmpapst.com

**Nominal data**

Type	8214 JH4	
Nominal voltage	VDC	24
Nominal voltage range	VDC	12 .. 27.6
Speed	min <sup>-1</sup>	14000
Power input	W	38
Min. ambient temperature	°C	-20
Max. ambient temperature	°C	70
Air flow	m <sup>3</sup> /h	222
Sound power level	B	7.8
Sound pressure level	dB(A)	71

ml = Max. load · me = Max. efficiency · fa = Running at free air · cs = Customer specs · cu = Customer unit  
 Subject to alterations



**Technical features**

<b>General description</b>	* Free air power consumption, these values may be considerably higher at the operating point.
<b>Housing material</b>	Fibreglass-reinforced plastic (PBT)
<b>Impeller material</b>	Fibreglass-reinforced plastic (PA)
<b>Mass</b>	0.200 kg
<b>Dimensions</b>	80 x 80 x 38 mm
<b>Direction of air flow</b>	Air exhaust over bars
<b>Direction of rotation</b>	Left, looking at rotor
<b>Bearing</b>	Ball bearings
<b>Lifetime L10 at 40 °C</b>	50000 h
<b>Lifetime L10 at maximum temperature</b>	25000 h
<b>Connection line</b>	Single strands AWG 22, TR 64, bared and tin-plated.
<b>Motor protection</b>	Protected against reverse polarity and locking.
<b>Option</b>	Speed signal

## Product drawing

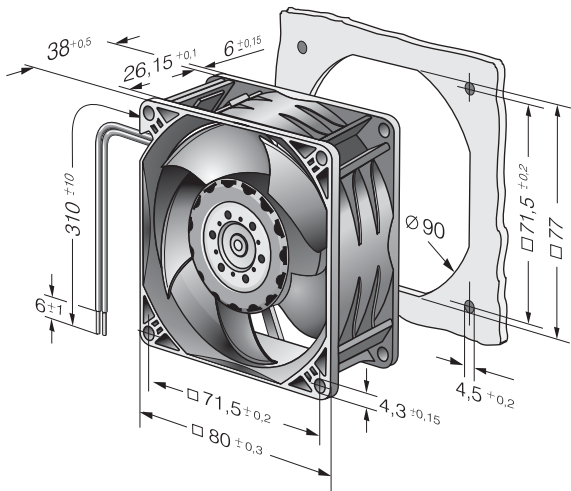

## Charts: Air flow

